

LINSEIS

T H E R M A L A N A L Y S I S

**SEEBECK COEFFICIENT
ELECTRIC RESISTANCE
ZT-MEASUREMENT**

LSR

NEW

Exciting new features including
Harman measurements and
Impedance Spectroscopy

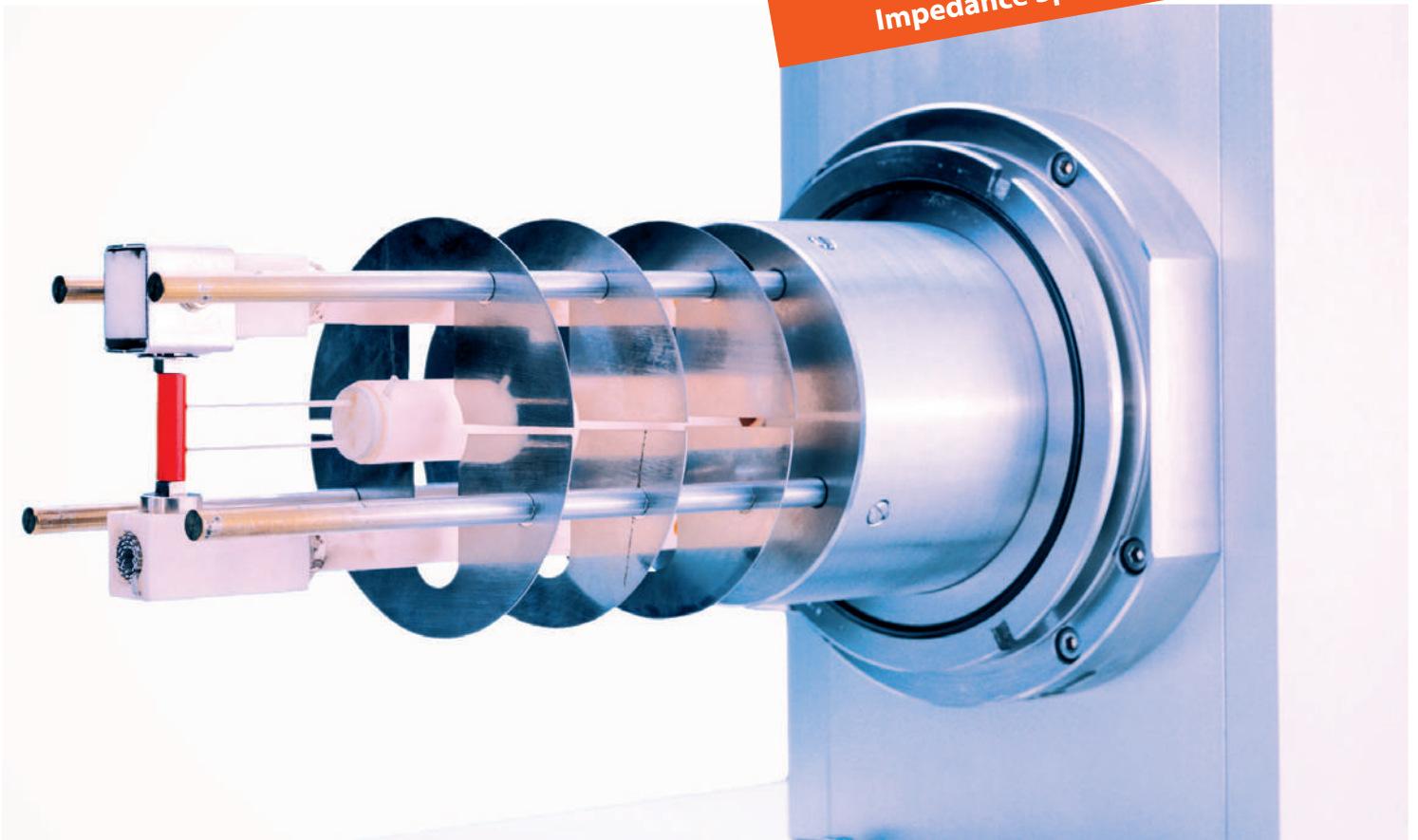

Since 1957 LINSEIS Corporation has been delivering outstanding service, know how and leading innovative products in the field of thermal analysis and thermo physical properties.

Customer satisfaction, innovation, flexibility and high quality are what LINSEIS represents. Thanks to these fundamentals, our company enjoys an exceptional reputation among the leading scientific and industrial organizations. LINSEIS has been offering highly innovative benchmark products for many years.

The LINSEIS business unit of thermal analysis is involved in the complete range of thermo analytical equipment for R&D as well as quality control. We support applications in sectors such as polymers, chemical industry, inorganic building materials and environmental analytics. In addition, thermo physical properties of solids, liquids and melts can be analyzed.

LINSEIS provides technological leadership. We develop and manufacture thermo analytic and thermo physical testing equipment to the highest standards and precision. Due to our innovative drive and precision, we are a leading manufacturer of thermal Analysis equipment.

The development of thermo analytical testing machines requires significant research and a high degree of precision. LINSEIS Corp. invests in this research to the benefit of our customers.



Claus Linseis
Managing Director



German engineering

The strive for the best due diligence and accountability is part of our DNA. Our history is affected by German engineering and strict quality control.

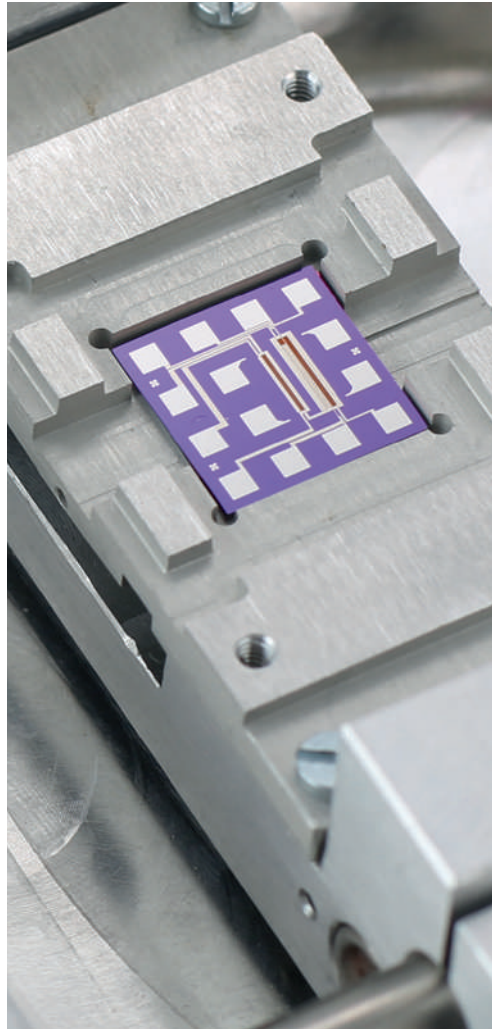

Innovation

We want to deliver the latest and best technology for our customers. LINSEIS continues to innovate and enhance our existing thermal analyzers. Our goal is constantly develop new technologies to enable continued discovery in Science.

GENERAL



The thermal power, thermoelectric power or Seebeck coefficient of a material measures the magnitude of an induced thermoelectric voltage in response to a temperature difference across that material. The thermal power has units of (V/K).

In recent years, much interest has been shown in various methods of direct conversion of heat into electricity. Waste heat from hot engines

and combustion systems could save billions of dollars if it could be captured and converted into electricity via thermoelectric devices.

For the challenging task of thermoelectric material characterization, LINSEIS has developed the unique LSR-4 Seebeck and Electric Resistivity unit, which is an advanced version of the well known LINSEIS LSR-3.

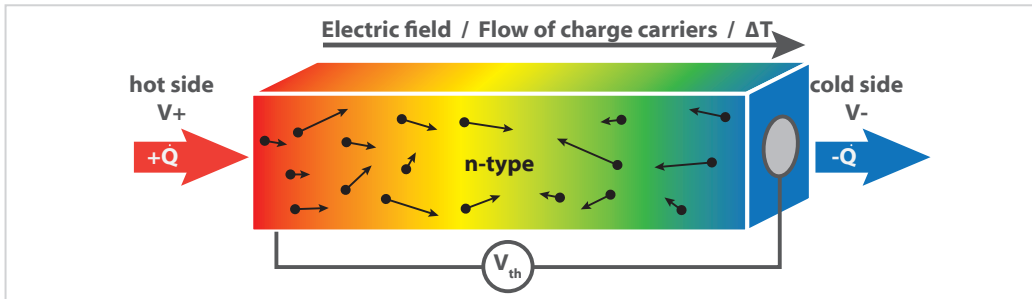

LINSEIS metrology for thermoelectrics

To enable advanced research in the field of thermoelectrics, LINSEIS offers a complete range of instruments for this demanding task. The instruments available involve LSR 3/4 for Seebeck coefficient and Electric Resistivity measurements, HCS for Hall Effect determination, LFA (Laser- / Light Flash Analyzer) for thermal diffusivity and thermal conductivity measurements as well as Dilatometer for thermal expansion and density and Differential Scanning Calorimeters (DSC) for Specific Heat (cp) measurement.

This broad range of instruments allows a complete thermoelectric characterization of promising thermoelectric materials and thus the calculation of the dimensionless figure of merit ZT, which is mostly used for the comparison of the thermoelectric conversion efficiency.

$$ZT = \frac{S^2 \cdot \sigma \cdot T}{\lambda}$$

Seebeck Coefficient; [S] = $\mu\text{V/K}$
 Electrical Conductivity; [σ] = $1/\Omega\text{m}$
 Thermal Conductivity; [λ] = W/mK

LINSEIS LSR

The LINSEIS LSR allows the simultaneous determination of the Seebeck coefficient (S) and electrical resistivity (ρ) of a bulk or thin film sample material over a broad temperature range. As the electrical conductivity is the reciprocal value of

the resistivity, it can be simply calculated from the measured data using the formula: $\sigma = \frac{1}{\rho}$ follows the electrical conductivity σ .

Features

The LSR - 3 can simultaneously measure both, Seebeck coefficient and electric resistance (Resistivity) and offers the following features:

- Prism, square and cylindrical samples with a length between 6 to 22mm can be analyzed
- Thin films and foils can be analyzed with a unique measurement adapter
- Three different exchangeable furnaces cover the temperature range from -100 up to 1500°C
- The design of the sample holder guarantees highest measurement reproducibility
- State of the art 32-Bit software enables automatic measurement procedures
- Measurement data can be easily exported

Optional LSR 4 upgrade

In extension to the successful LSR-3 unit, the LSR-4 includes the Harman option for the direct determination of the dimensionless figure of merit ZT. This powerful integrated setup (patent pending) allows not only the direct ZT measurement, but also the calculation of the thermal conductivity (λ) with the existing system. More details can be found on page 8.

PRINCIPLES OF MEASUREMENT

Seebeck Coefficient

A sample of cylindrical, square or prism shape is vertically positioned between two electrodes. The lower electrode block (and optional also the upper electrode block for a temperature gradient inversion) contains a heater, while the entire measuring arrangement is located in a furnace, which heats the sample to a specified temperature.

At this temperature, the secondary heater in the lower electrode block creates a set temperature gradient. Two contacting thermocouples T_1 and T_2 then measure the temperature difference (ΔT

$= T_2 - T_1$) between the hot side and the cold side of the sample. In addition, one wire of each of the two thermocouples is used to measure the occurring electromotive force dE (respectively Thermovoltage V_{th}). A unique spring based thermocouple mechanism permits best possible electric contacts and thus highest accuracy measurements.

From the obtained data, the Seebeck coefficient can easily be calculated with the formula:

$$S = \frac{-V_{th}}{\Delta T} .$$

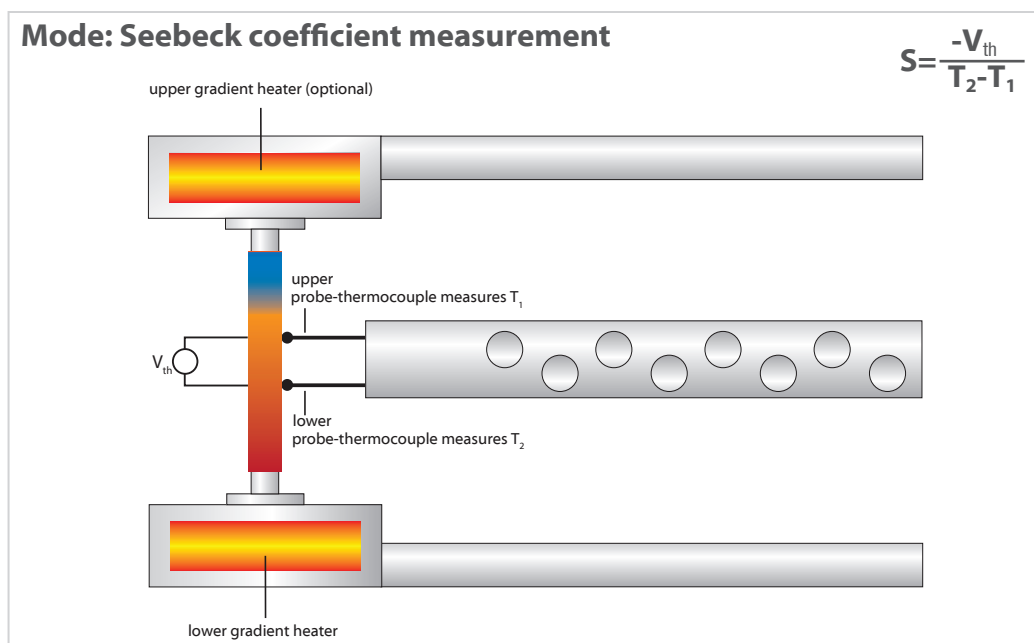

Electric Resistivity / Electric Conductivity measurement

For the determination of the samples electric resistance, the dc four terminal method is used, which allows to neglect parasitic effects, like contact or wire resistances. For the measurement, a constant current (I_{DC}) is applied through the upper and lower electrode and the corresponding voltage drop (V_{Ω}) along the sample is measured between one wire at each of the two thermocouples.

From the obtained data, and with the knowledge of the probe distance as well as cross-sectional sample area, the resistivity and conductivity can easily be calculated using the formula:

$$\rho = \frac{U}{I} \cdot \frac{A}{L} \quad \text{and} \quad \sigma = \frac{1}{\rho}$$

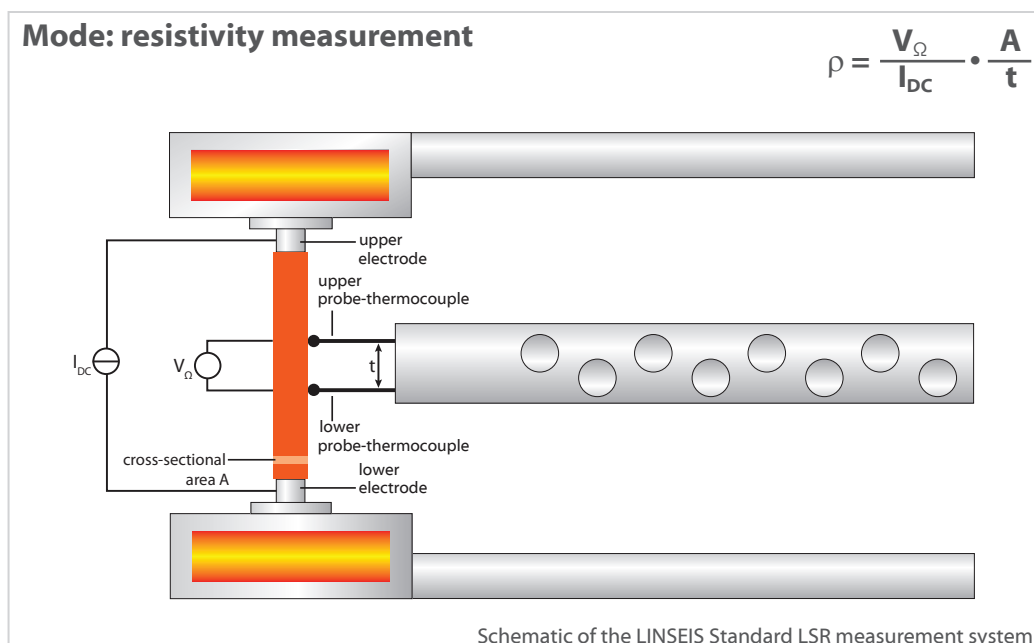

Direct ZT measurement (Harman / Impedance Spectroscopy)

The Harman method assesses the thermoelectric figure-of-merit ZT of a material based on its voltage responses to a direct current (DC) applied to the sample. When an external current is driven through a thermoelectric sample located between the two needle contacts, local heating / cooling will occur at the intersection because of the thermoelectric peltier effect. As a consequence of this and the nearly adiabatic boundary conditions, a characteristic temperature profile (temperature gradient) will be achieved over the sample. From the measure-

ment of the initial voltage drop (ohmic part without heating) and the steady state voltage drop (including thermovoltage) the dimensionless figure of merit ZT (and from this also the thermal conductivity λ) can be calculated.

$$ZT = \frac{V_{th}}{V_{\Omega}}$$

Unlike the separate measurements of S , ρ , and λ , the Harman method requires only a single apparatus and a single sample preparation, hence essentially involves smaller uncertainties in the measurements. Adversely, the possible temperature range of this add on is only possible until 400°C.

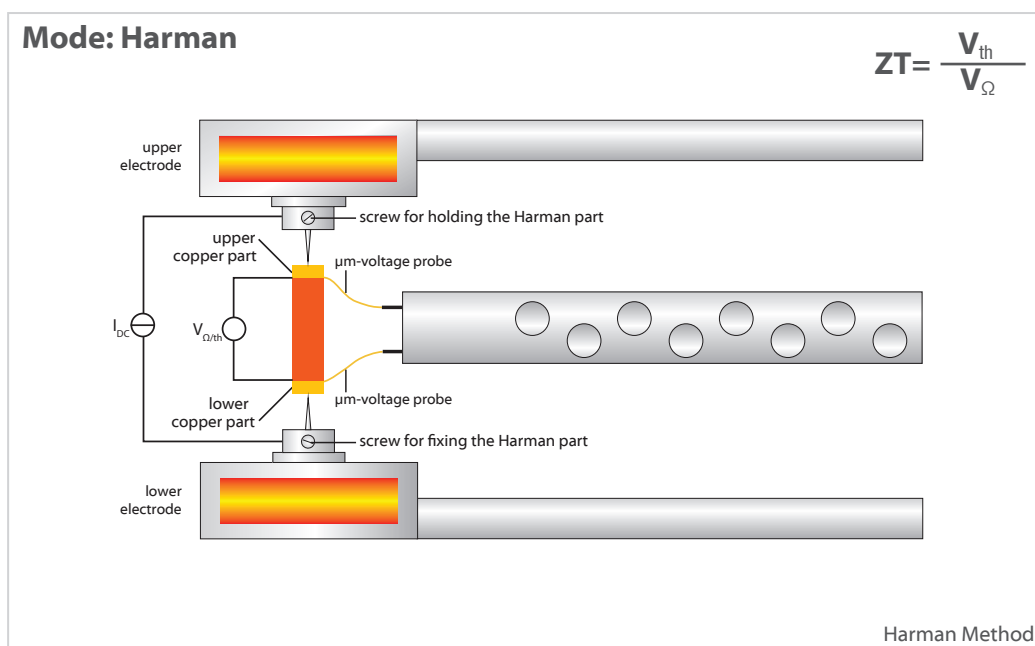

Impedance spectroscopy

In extension to the steady state Harman method, the Linseis LSR-4 unite can be equipped with our unique LSR-AC electronics, which allows the implementation of a impedance spectroscopy. Thus, the direct ZT measurement is not only possible for single legs, but also of modules,

like Peltier Elements or Thermoelectric Generators (TEG). The evaluation of measurement data if fulfilled according to the Canadas model and can be adapted to a variety of different module designs.

Thermoelectric Leg

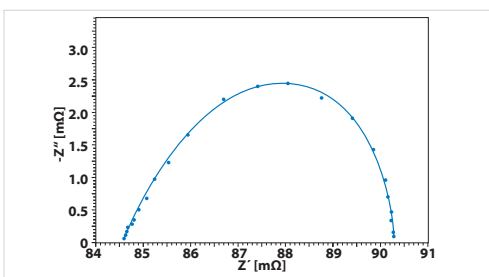
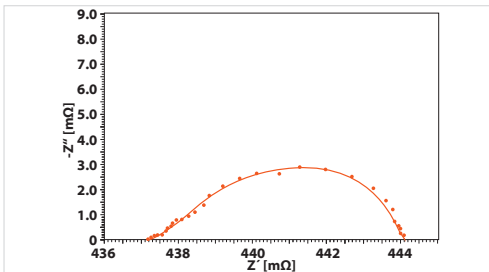

Thermoelectric module

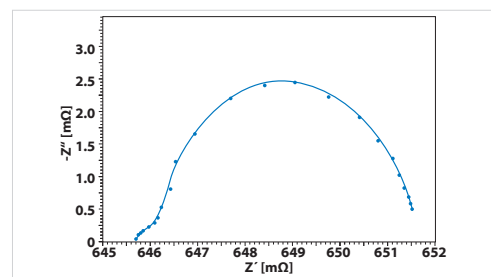
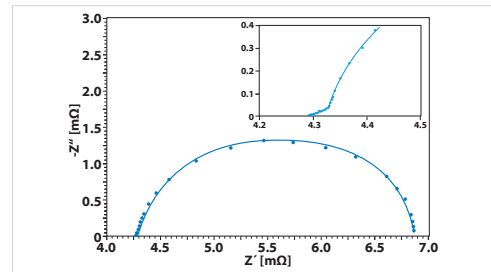

Fitting parameters and extracted thermal properties

Sample	R (Ω)	R _{TE} (Ω)	ω _{TE} (rad/s)	C _{TE} (F)	λ _{TE} (W/mK)	α _{TE} (cm ² /s)	C _{pTE} (J/gK)	S (μV/K)	R _C (Ω)	ω _C (rad/s)
Element	0.084	0.0058	2.0	86.21	1.27	0.013	0.13	—	—	—
module	4.292	2.585	0.24	1.61	1.60	0.0013	1.56	191.5	0.149	6.08

* García-Cañadas, Jorge, and Gao Min. „Impedance spectroscopy models for the complete characterization of thermoelectric materials.“ *Journal of Applied Physics* 116.17 (2014): 174510.

POSSIBLE SAMPLE GEOMETRIES

The LSR instrument can handle 3 different sample geometries, rod shaped, (up to \varnothing 6 mm x 23 mm height) bar shaped (square footprint up to 6 mm and 23 mm height) or disc shaped (10 mm, 12.7 mm or 25.4 mm). The samples footprint should ideally be smaller than or equal to the electrodes surface size, as a 1-dimensional current flow and heat flux through the sample is required for an accurate measurement.

While rod and bar shaped samples are the typical configuration for thermoelectric legs in generators (TEG), the disc shaped samples can not only be characterized in the LSR Seebeck & Electric Resistivity Analyzer, but also in the Linseis LFA Laser/Light Flash System for the thermal conductivity measurement without further processing necessary.

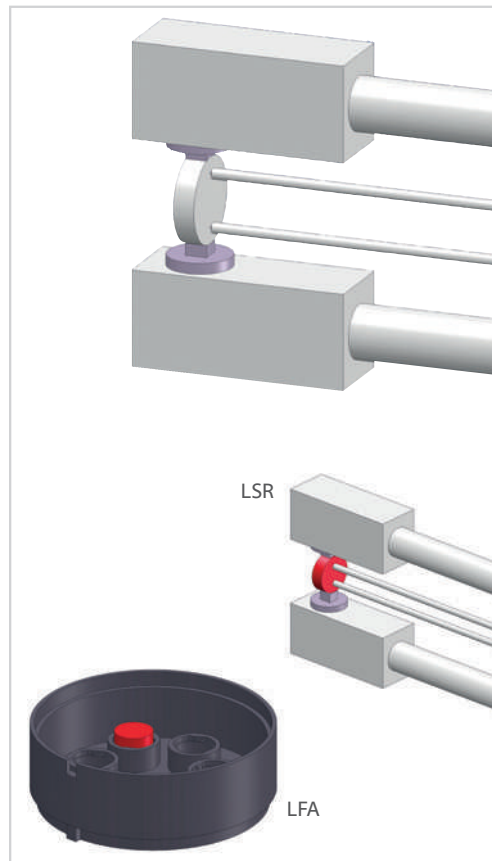
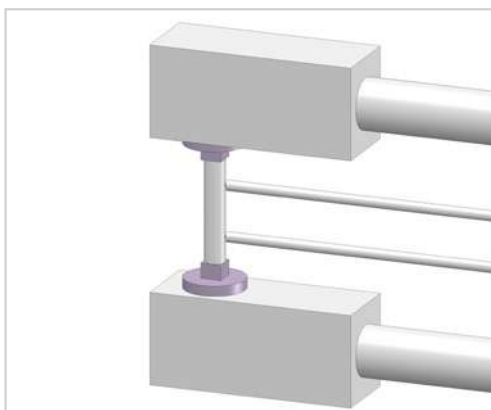
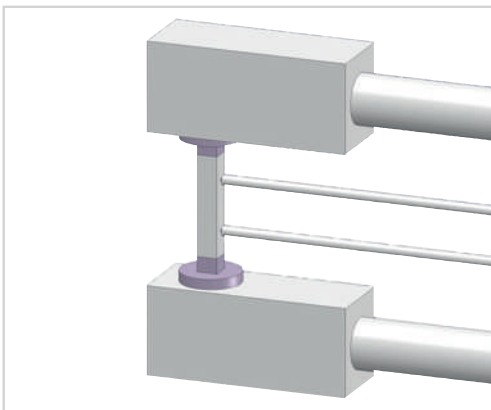

THIN FILM ADAPTER

Free Standing Films and Foils

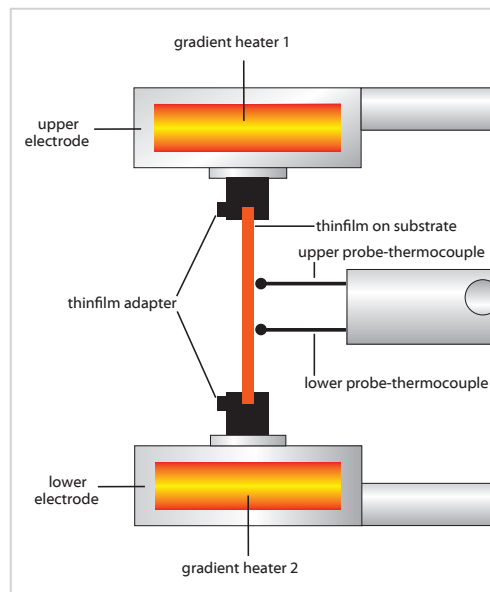
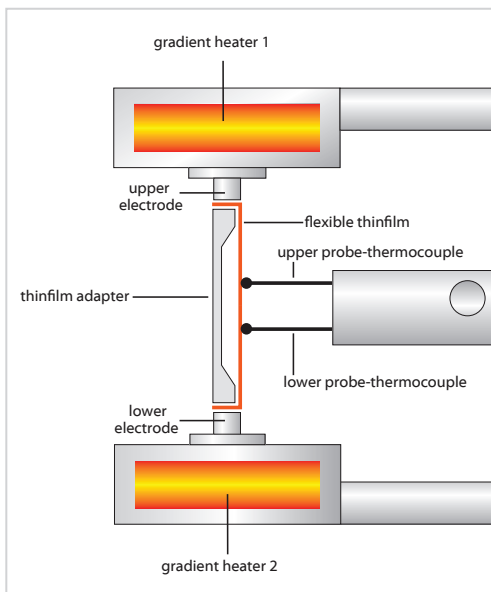

In recent years, there has been increasing interest in research on nanostructured samples like thin films or nanowires due to their considerable different properties compared to bulk material. In order to meet the requirements of today's research, LINSEIS developed two different sample holder dedicated for either free standing films

and foils or coatings on a substrate. Thanks to the unique design of the sample holders, sample preparation restrictions could be limited to an absolute minimum and a broad range of samples, respectively samples on substrate combinations, can be characterized.

HIGH RESISTANCE

The unique LINSEIS LSR-3 high resistance option in combination with the adjustable thermocouples placement for minimum probe distance allows the characterization of challenging samples with conductivities as low as 0.01

S/cm and below. This unique feature offers a substantial benefit for research and quality control applications only the LINSEIS LSR platform can provide.

THERMOCOUPLE OPTIONS

Unsheathed thermocouples (Standard)

for highest precision measurements

Sheathed thermocouples

for challenging samples

Type K/S/C thermocouples

Type K for low temperature applications

Type S thermocouples for high temperature applications

Type C thermocouples for special applications like Pt poisoning samples

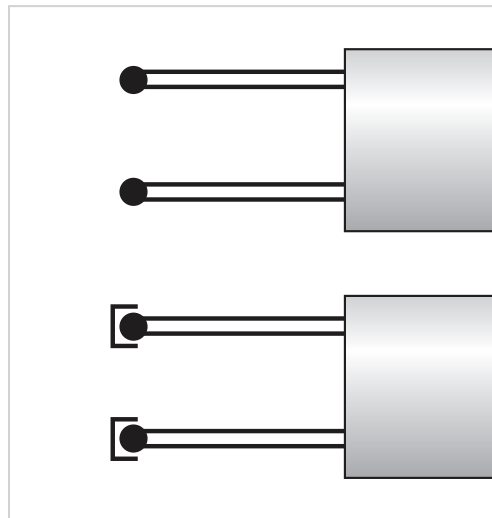

CAMERA OPTIONS

- camera option for probe distance measurements
- allows high accuracy resistivity measurements
- including software package

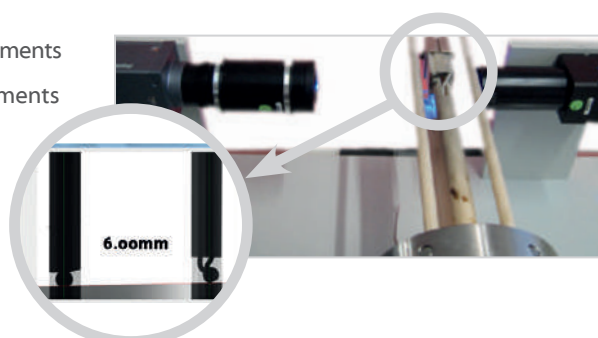

HIGH SPEED IR FURNACE

The LFA unit is equipped with a high speed IR furnace. This technology enables unmatched heating and cooling speed of the system, providing highest sample throughput. In addition

the infrared technology provides unmatched temperature control, homogeneity and precision, which is the basis for a highly accurate measurement.

Because Time Matters

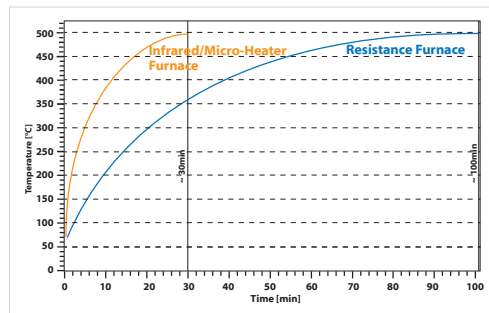
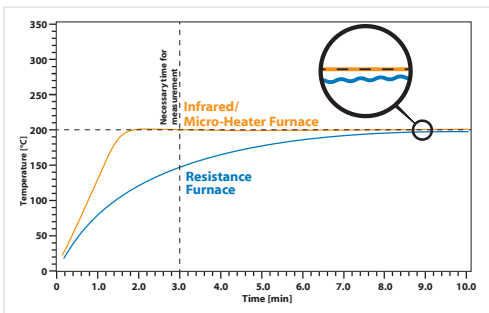

Elapsed time for temperature dependent measurement run

**High speed
heating / cooling**

**High sample
throughput**

**Superior tempera-
ture stability
→ best measure-
ment accuracy**

SOFTWARE

All LINSEIS thermo analytical instruments are PC controlled. The individual software modules exclusively run under Microsoft® Windows® operating systems. The complete software consists of 3 modules: temperature control, data acquisition and data evaluation. The software incorporates all essential features for measurement preparation, execution, and evaluation of a LSR-3 measurement. Thanks to our specialists and application experts, LINSEIS was able to develop comprehensive easy to understand user friendly application software.

General Features

- Program capable of text editing
- Repetition measurements with minimum parameter input
- Evaluation of current measurement
- Curve comparison up to 32 curves
- Curve subtraction
- Multi-methods analysis (DSC TG, TMA, DIL, etc.)
- Zoom function
- 1. and 2. Derivative
- Complex peak evaluation
- Multipoint calibration for sample temperature
- Storage and export of evaluations
- Export and import of data ASCII
- Data export to MS Excel
- Signal-steered measuring procedures
- Zoom in function

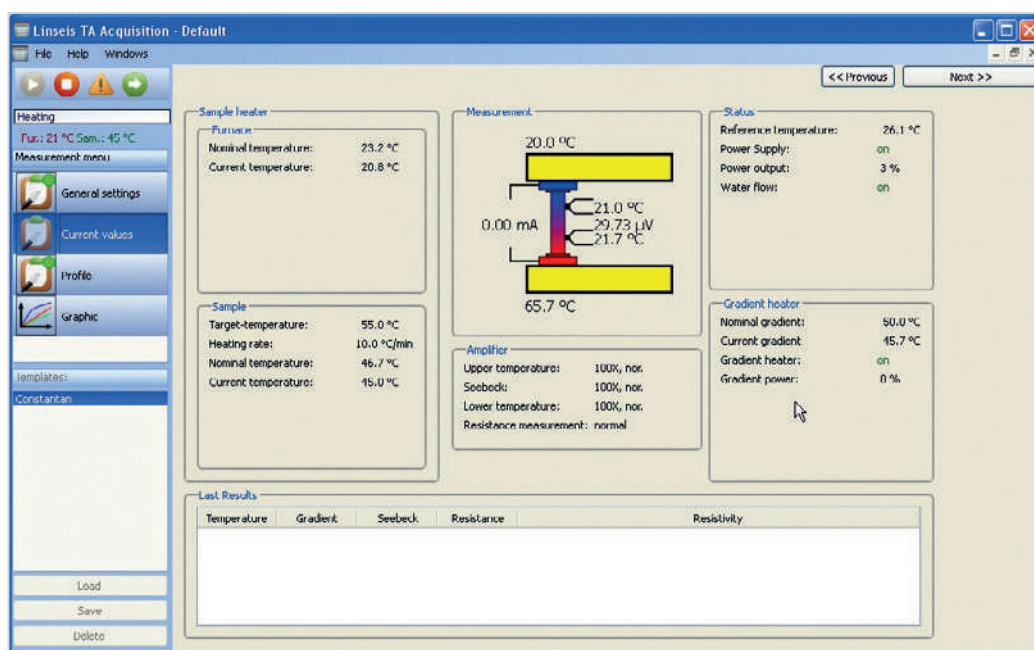

U/I-PLOT

For an accurate measurement of the resistivity, the electrical contact of the current contacts and voltage probes must be ensured. An easy and comfortable way is the Linseis U/I plot. If the correlation between applied current and occurring voltage is linear, the electric contact shows ohmic behaviour and thus is good for an accurate measurement. If the correlation shows non linear behaviour, the samples connection should be reviewed.

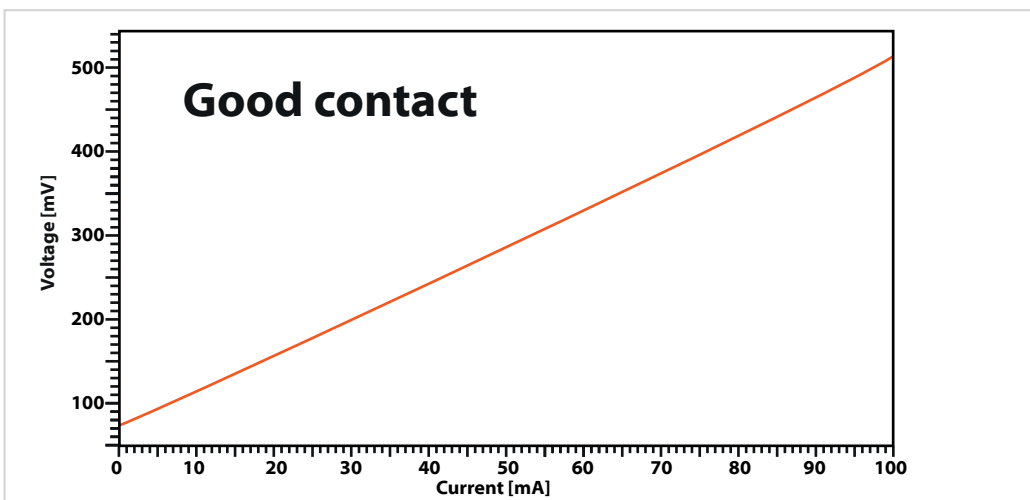
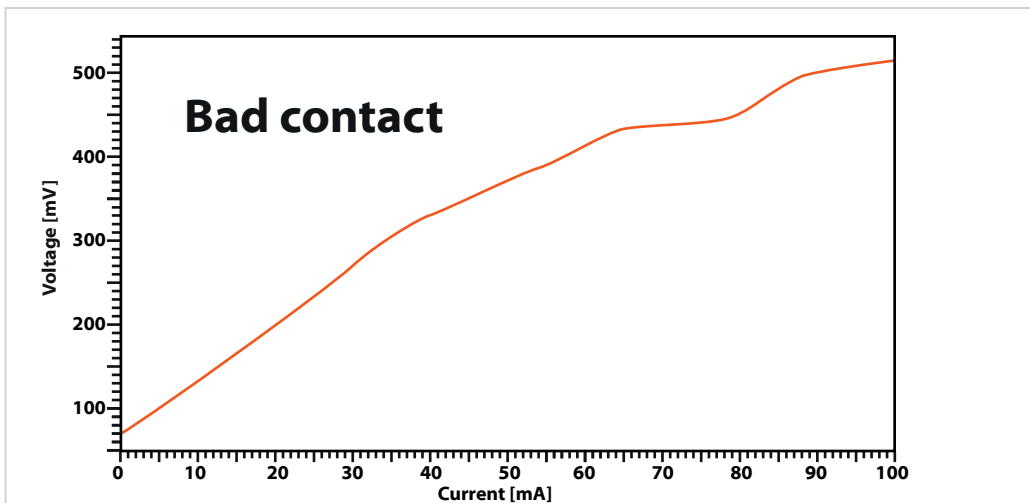
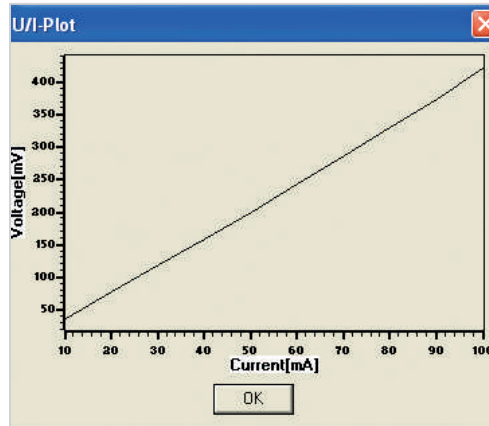

SPECIAL FEATURES

Nearly perfect 1-dimensional heat flux through the sample

High resistance option in combination with flexible probe distance provides most accurate results for challenging samples

Direct ZT measurement is possible using Harman (legs) or Impedance spectroscopy (legs and modules) upgrades

High speed infrared furnace for superior temperature control and higher sample throughput

Felixibility of thermocouples (Type, Sheathed or unsheathed)

Camera option for superior resistivity measurement accuracy

Thermal conductivity of legs and/or modules can be calculated using the Harman or impedance spectroscopy technique, respectively.

SPECIFICATIONS

	LSR 3
Temperature Range	-100 up to 500°C; RT up to 800/1100/1500°C
Measurement method	Seebeck coefficient: Static gradient / Slope method Electric resistance: four-terminal method
Specimen holder	sandwiched between two electrodes Unique thin film and foil adapter
Atmosphere	inert, oxid., red., vac.
Sample size (bar/zylinder)	2 to 5 mm width and depth / ø 6 mm and 6 to 23 mm height
Sample size round (Disc shape)	10, 12.7, 25.4 mm
Lead interval	4, 6, 8 mm
Cooling water	required
Measuring range Seebeck	1 up to 2500 µV/K Accuracy: ±7 % / Repeatability: ±3%
Measuring range Electrical conductivity	0.01 up to $2 \cdot 10^5$ S/cm Accuracy: ±5-8 %* / Repeatability: ±3 %
Current source	0 to 160 mA
Electrode material	Nickel (-100 to 500°C) / Platinum (-100 to 1500°C)
Thermocouples	Type K/S/C
	LSR 4 upgrade
DC Harman method	Direct ZT determination of TE legs
AC Impedance Spectroscopy	Direct ZT determination of Legs and Modules (Canadas model)
Temperature Range	-100 up to +400°C RT up tp 400°C
Specimen holder (LSR-4)	Needle contacts for adiabatic measurement conditions
Sample size	2 to 5 mm width and depth / ø 6 mm and 6 to 23 mm height Modules of various dimensions

APPLICATIONS

Measurement of the Constantan reference sample

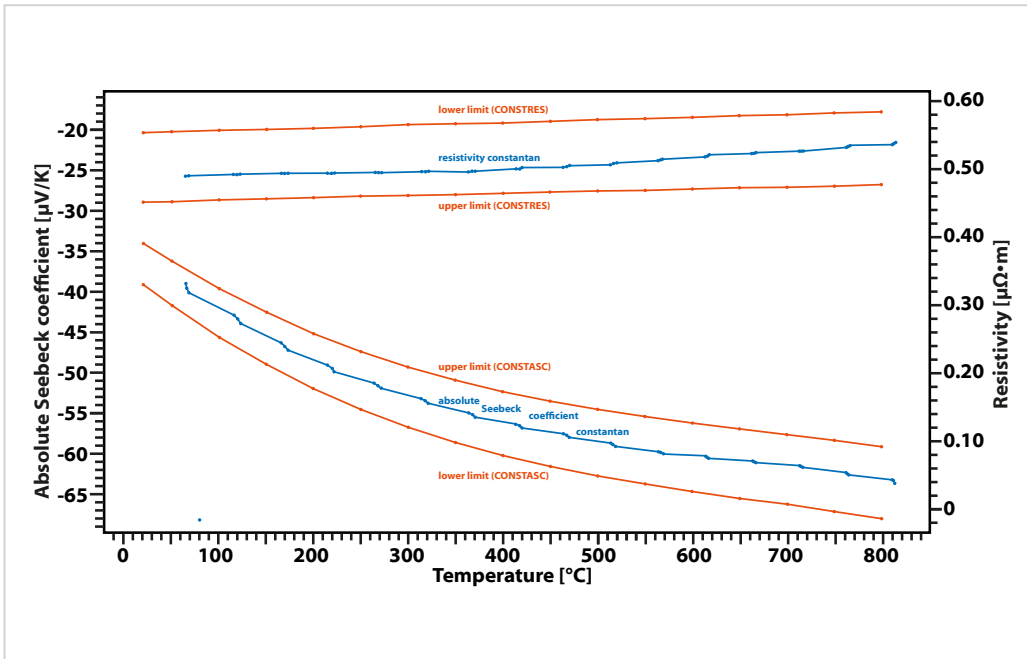

In contrast to the Bi_2Te_3 reference sample provided by NIST (SRM 3451)TM, which is only useable in the low temperature range until 390K, our Constantan reference sample can be used as a high temperature reference sample until 800°C. The measurement shows a typical evaluation measurement which fits nicely in the specified tolerances.

Electrical conductivity measurement of a highly conductive copper

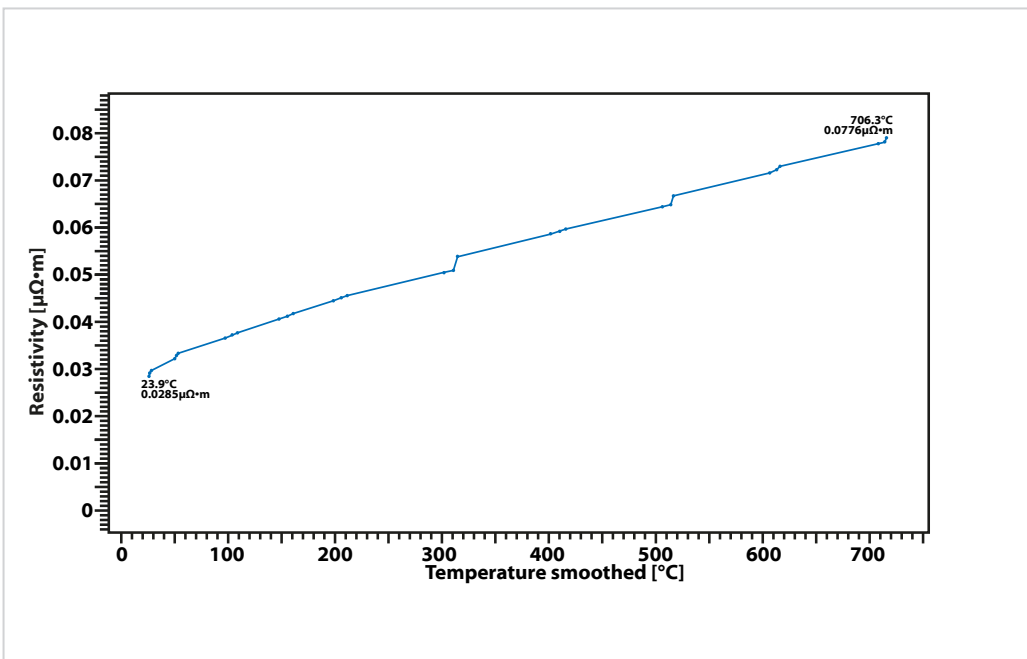

As copper is highly conductive, the measurement of the materials electrical resistivity can get very challenging. Nevertheless, due to the flexible measurement configuration, including adjustable probe distance and sample geometry, and the highly capable LINSEIS measurement electronic with a maximum measurement current of 160 mA, it was possible to measure even these challenging samples.

Electrical conductivity measurement of a SiGe alloy

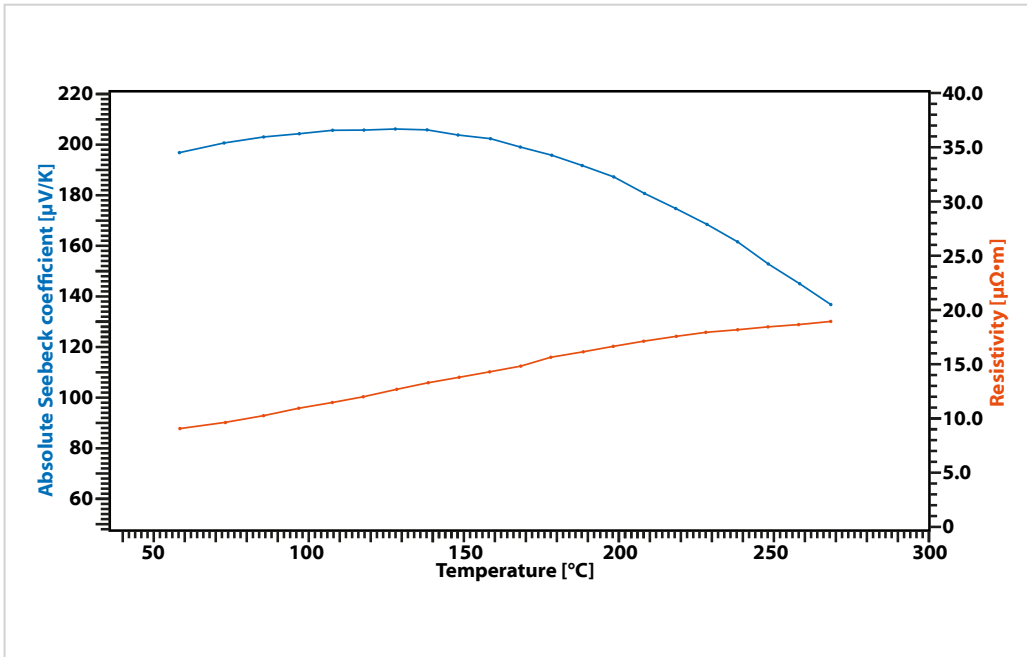

Silicon Germanium alloys are high temperature stable thermoelectric materials and thus are often used under challenging environmental conditions, like space missions or high temperature waste heat recovery. The measurement has been performed in order to check the low temperature behaviour of a new developed alloy.

Direct ZT measurement of the NIST Bi_2Te_3 reference sample

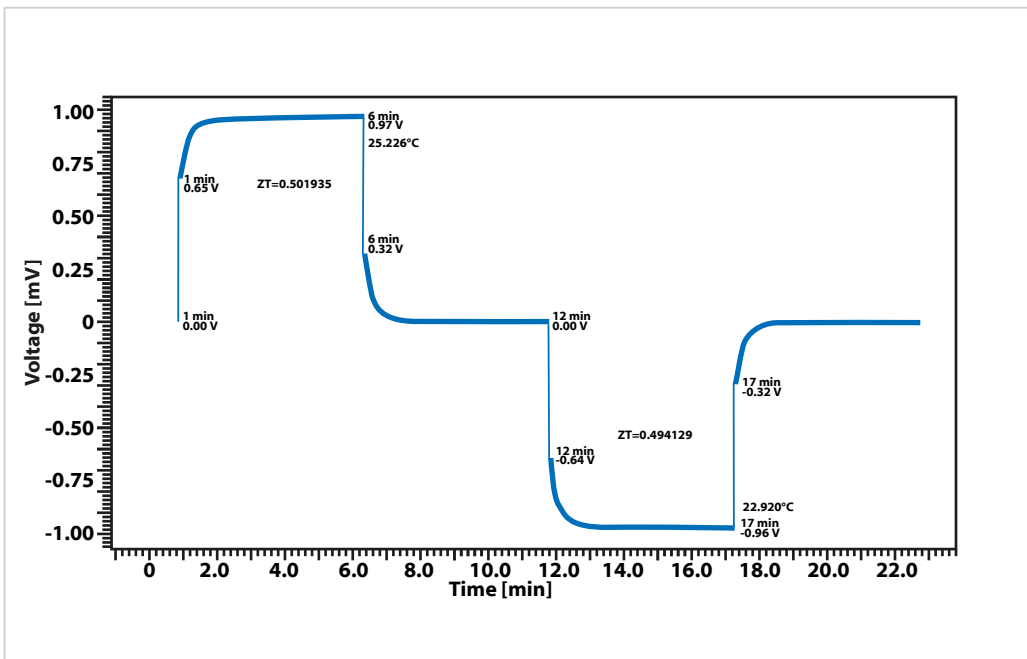

The NIST (SRM 3451)TM Bi_2Te_3 reference sample has been measured using the Harman method in combination with our LINSEIS LSR platform. The measurement clearly shows the typical voltage distribution at a single temperature measurement point. In this case, the ZT value at room temperature can be simply calculated by setting the ohmic voltage drop and the thermoelectric voltage drop in relation.

**LINSEIS GmbH Germany**

Vielitzerstr. 43

95100 Selb

Tel.: (+49) 9287 880 0

E-mail: info@linseis.de

**LINSEIS Inc. USA**

109 North Gold Drive

Robbinsville, NJ 08691

Tel.: (+1) 609 223 2070

E-mail: info@linseis.de

**LINSEIS China**

Kaige Scientific Park 2653 Hunan Road

201315 Shanghai

Tel.: (+86) 21 5055 0642

Tel.: (+86) 10 6223 7812

E-mail: info@linseis.de

**LINSEIS France**

2A Chemin des Eglantines

69580 Sathonay Village

Tel.: (+33) 6.24.72.33.31

E-mail: contact@ribori-instrumentation.com

**LINSEIS Poland**

ul. Dabrowskiego 1

05-800 Pruszków

Tel.: (+48) 692 773 795

E-mail: info@linseis.de

www.linseis.com**Products:** DIL, TG, STA, DSC, HDSC, DTA, TMA, MS/FTIR, In-Situ EGA, Laser Flash, Seebeck Effect, Thin Film Analyzer, Hall-Effect**Services:** Service Lab, Calibration Service

04/19

LINSEIS